

Article number: 604145032085

Description: Timing belt pulley with hub
HTD 32 14M 85

Measures

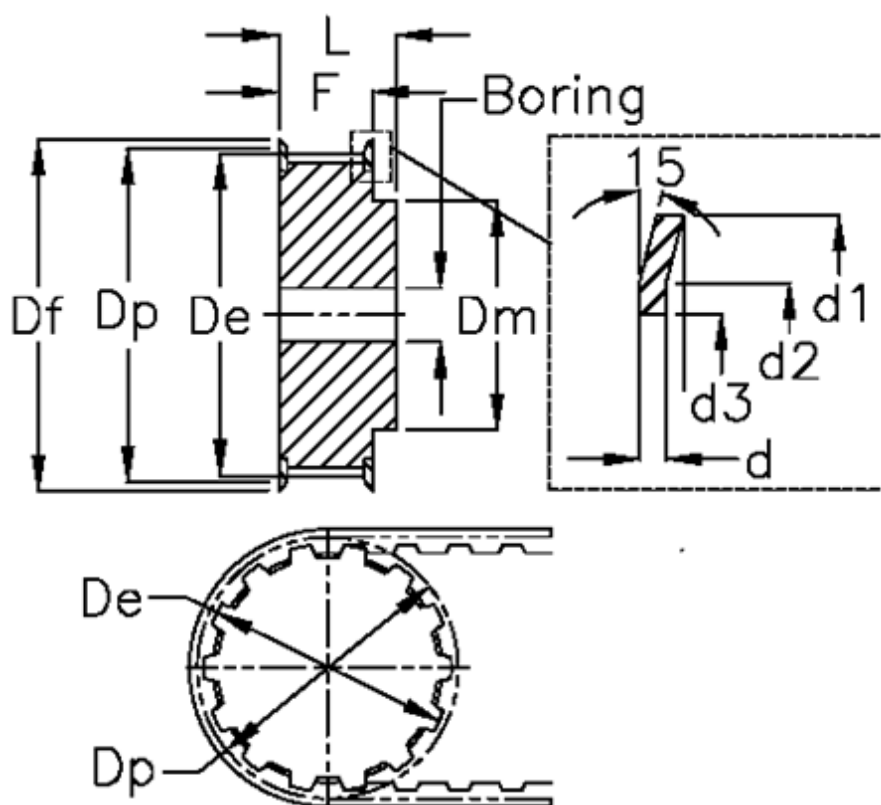

Bore = 24	Dp	= 142.6
d = 2.5	F	= 102
d1 = 154	Flange type	= F49
d2 = 142	L	= 117
d3 = 122	Tooth number	= 32
De = 139.88	Type	= 14M
Df = 154	Weight	= 10.5
Dm = 100	Width	= 85